

Para	Model	YT-M502	wired 2D scan module barcode reader
Picture			
Product Picture			
Performance Parameter			
Depth Filed			
Infrared induction distance	150 - 200mm		
Optical Source	620nm Visible red light diode		
Imaging Sensor	CMOS		
Resolution Ratio	30 million pixels		
Image Resolution	≥ 5mil		
Minimum Contrast	≥ 30%		
Barcode Types	1D CODE128 EAN-8 EAN-13 UPC-E UPC-A Interleaved 2 of 5 ITF14 MATRIX 25 Code39 Codabar Code93 UCC/EAN-128 Code11 ISBN INDUSTRIAL25 STANDARD25 Plessey MSI_Plessey 2D PDF417 QR Aztec DataMatrix Maxicode MicroPDF417 SPEC_OCR_B		
Barcode Sensitivity	Tilt	± 55°	
	Rotate	± 25°	
	Deflection	± 75°	
Data Interface Port	USB RS232		
Mechanical and Electric Performance			
Size(Length x Width x Height)	50mm×37mm×21mm		
Weight	3.7g		
Indicator	Siren and LED light		
Max.Power	1060mw		
Working Voltage	5V		
Current	Max.Current	212mA	
	Working Current	156mA~212mA	
	Stand-by Current	156mA	
Environmental Parameter			
Storage Temperature	-40° C ~ 60° C		
Working Temperature	0° C ~ 50° C		
Relative Humidity	0 ~ 95%		
Height Range	1.5m		
IP Rating	IP52		

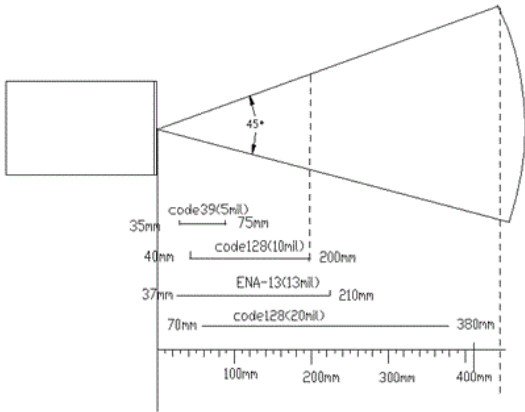